

# Сидящий олень

Jun Maekawa  
Viva! Origami

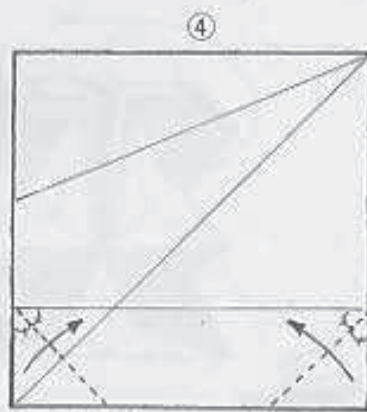

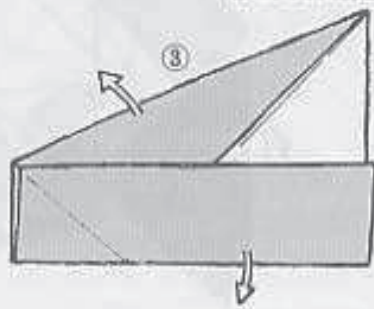

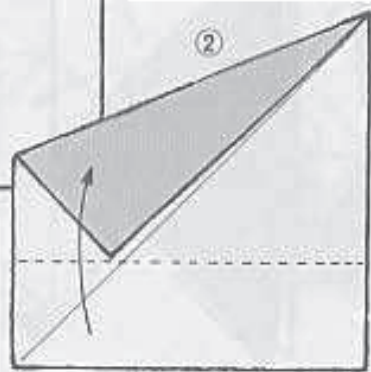
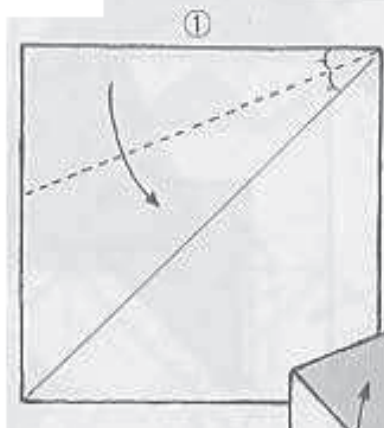
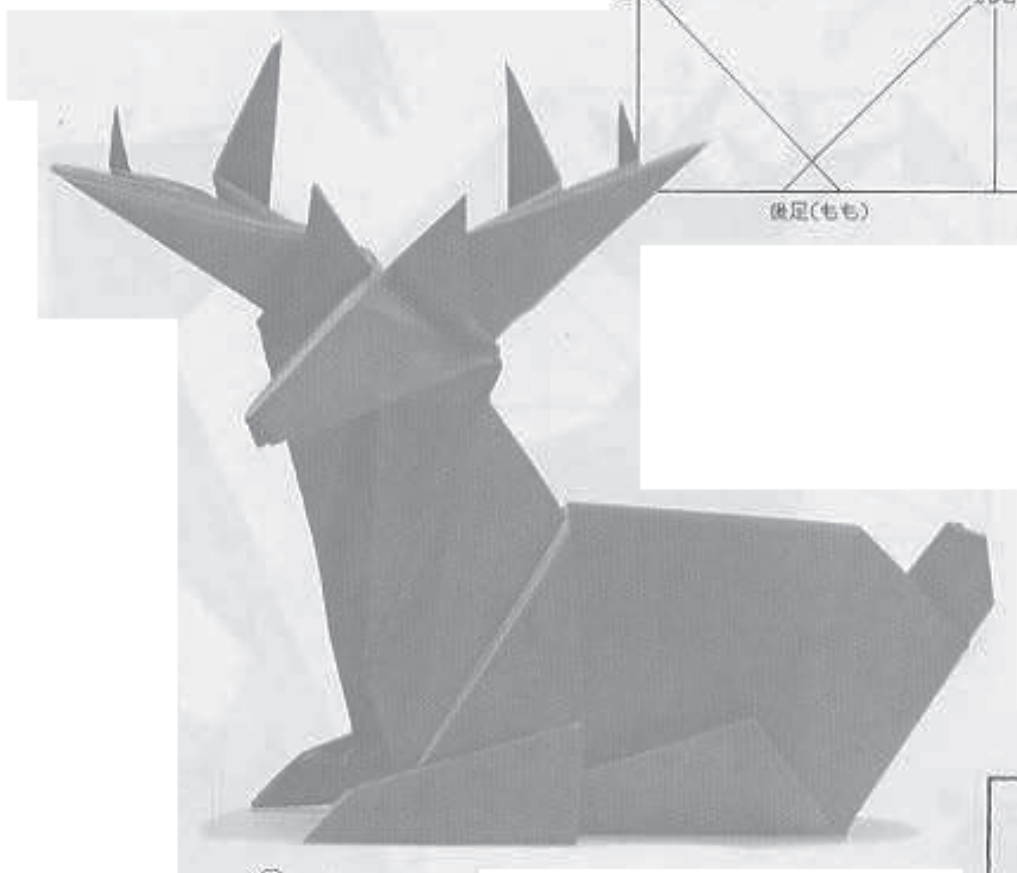
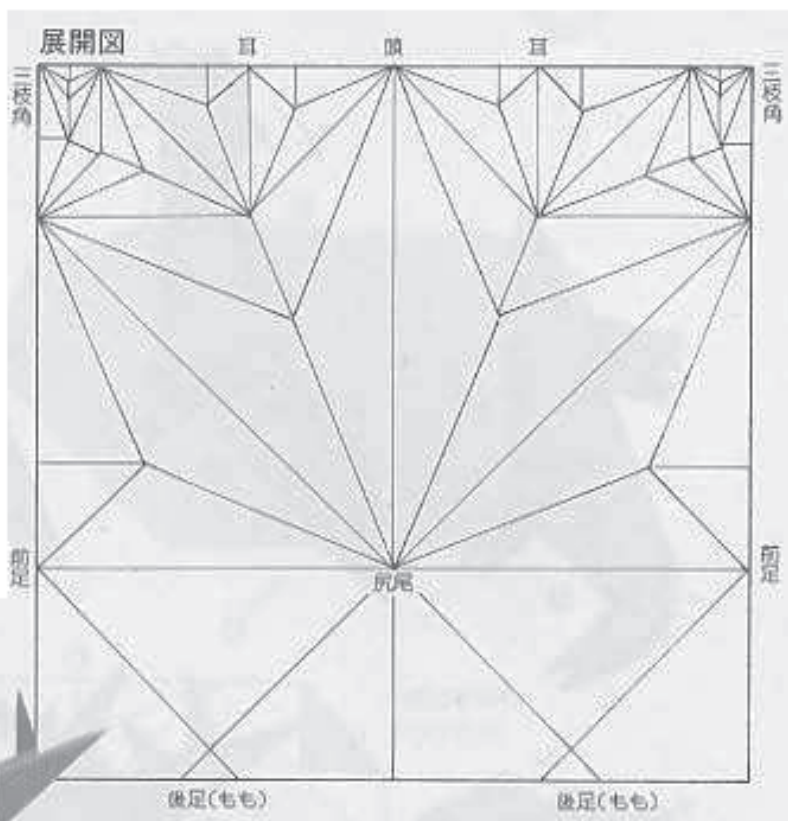
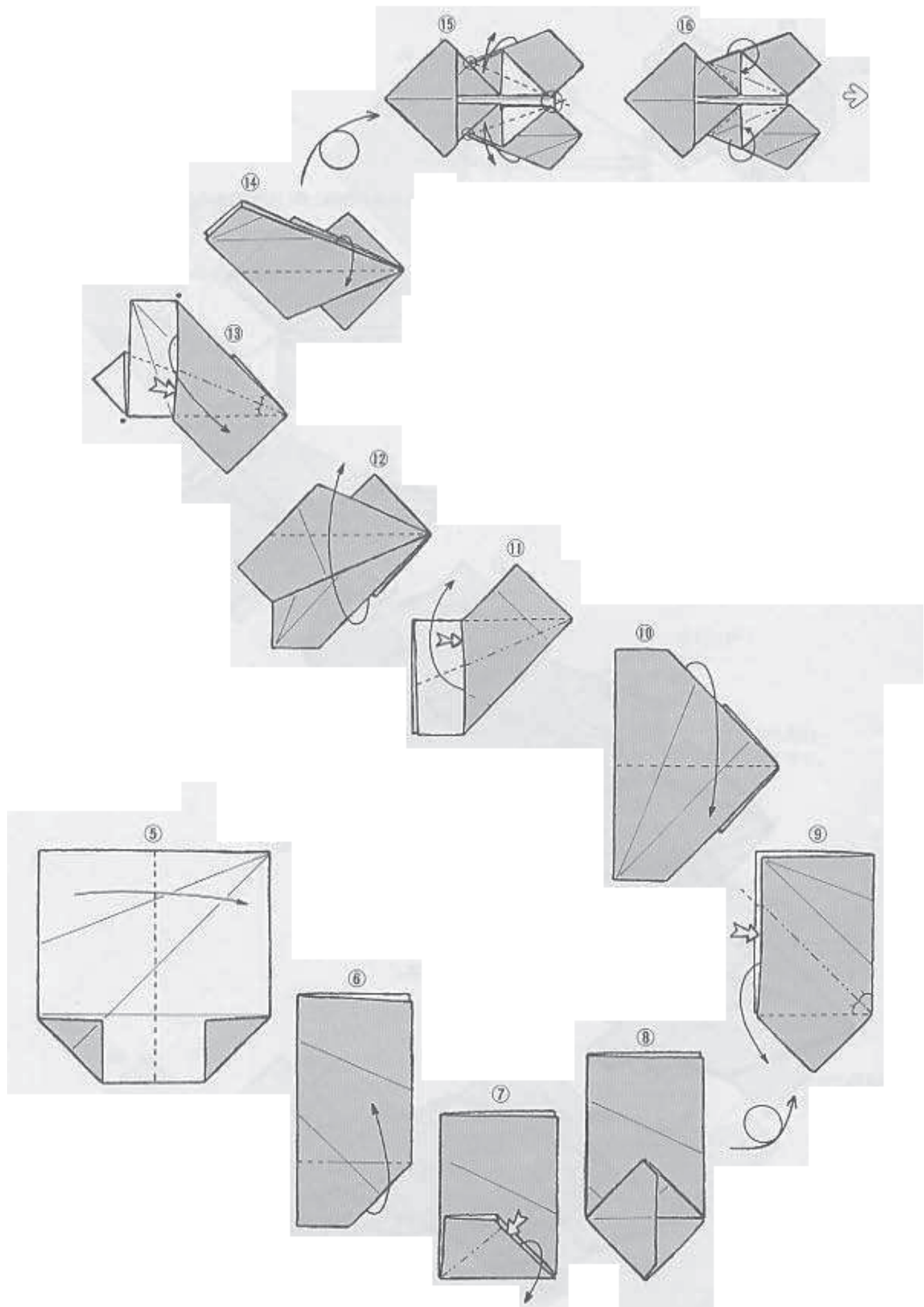
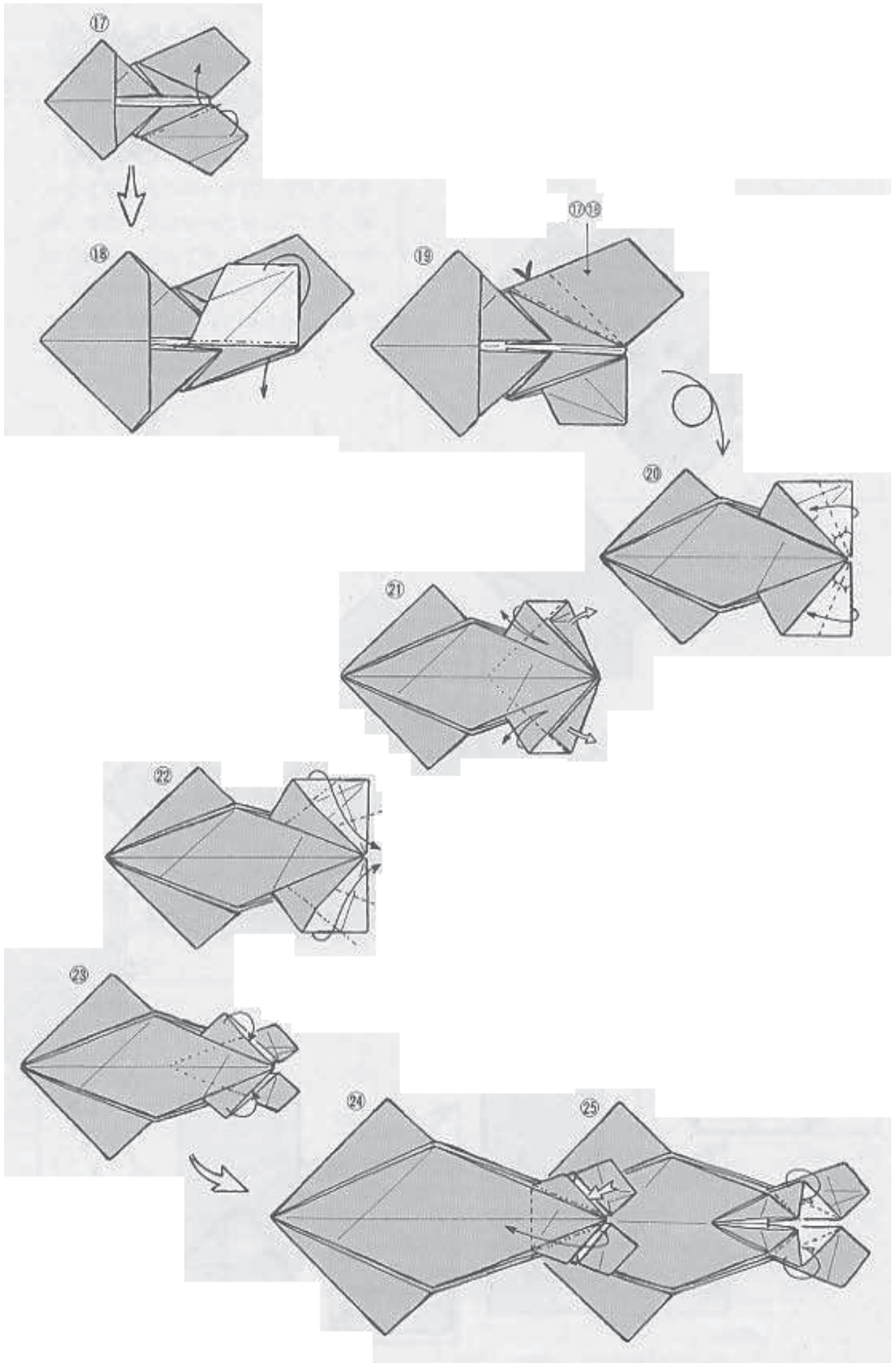



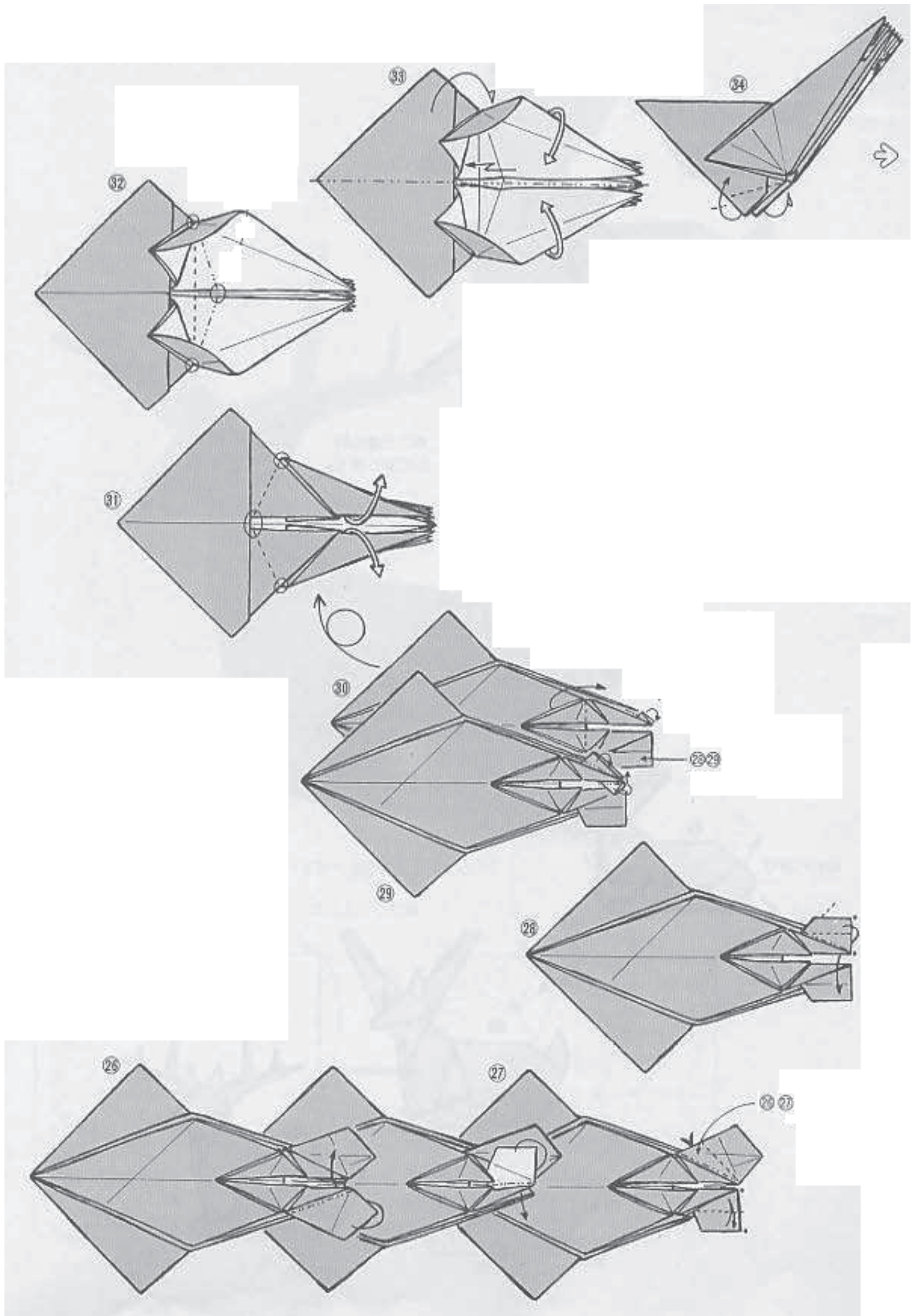

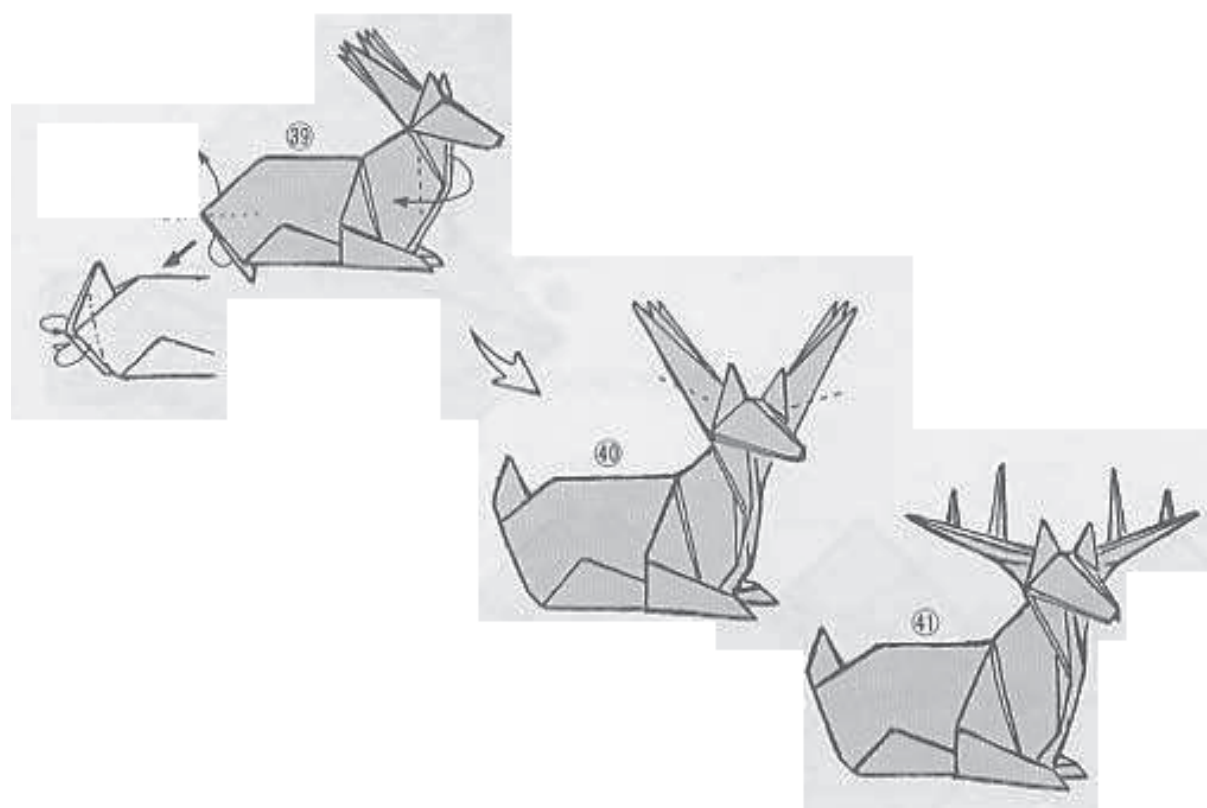
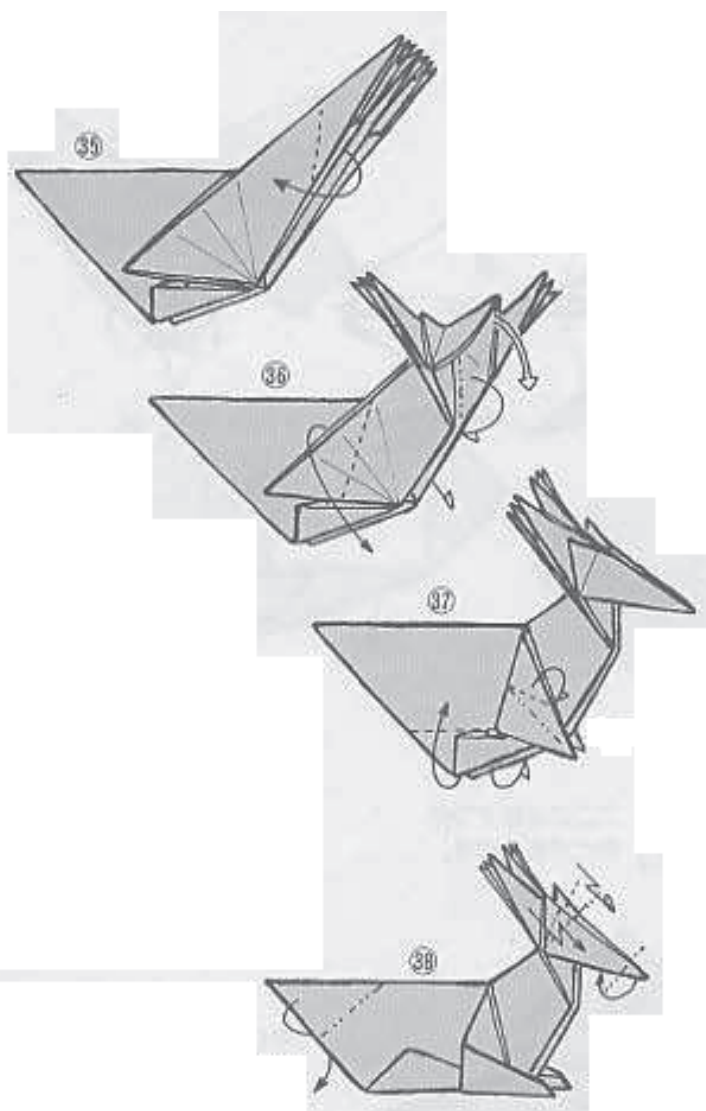



Паттерн стоящего оленя

↑  
展開図

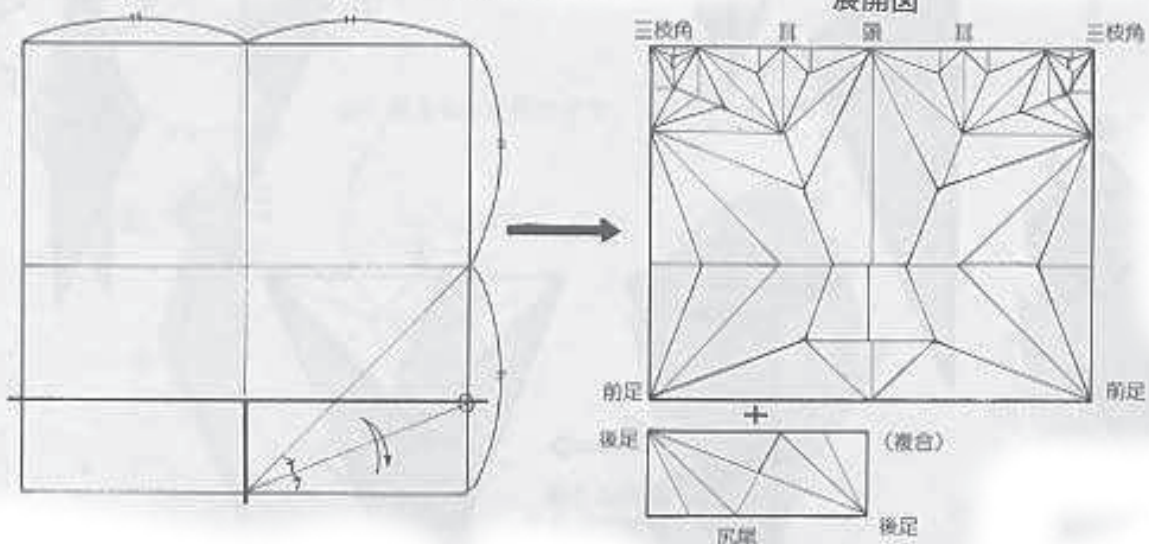



# Северный олень

John Montroll  
Christmas Origami

1

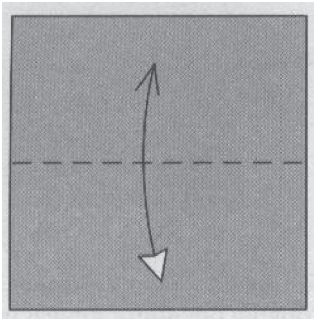

2

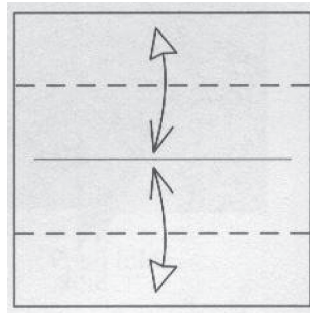

3

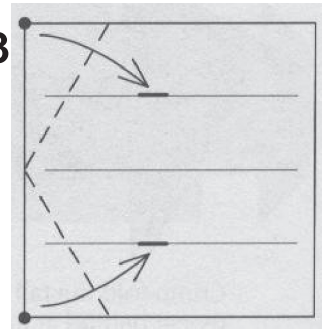

4

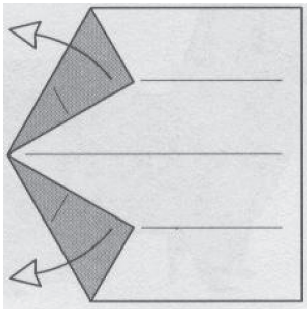

5

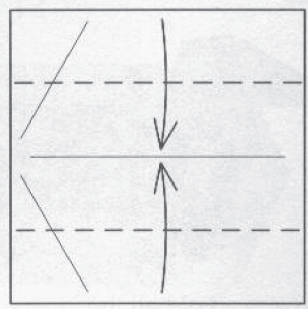

6

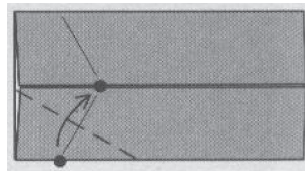

7

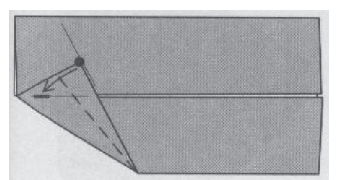

8

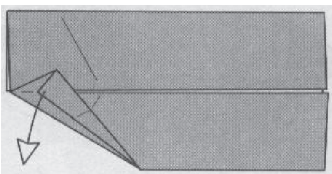

9

6-8

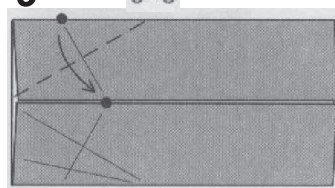

10

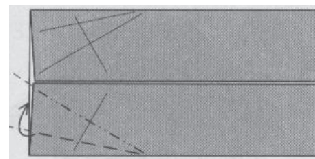

11

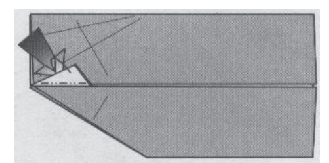

12

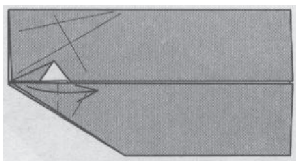

13

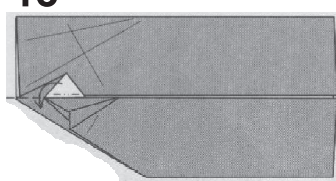

14

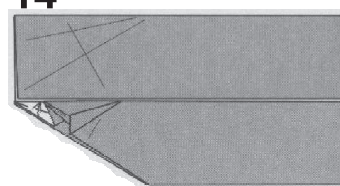

15

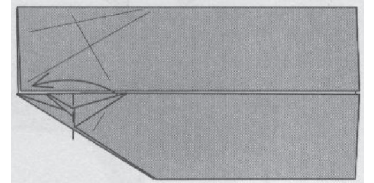

16

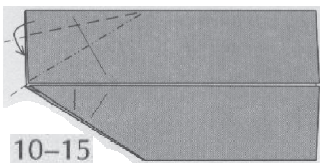

17

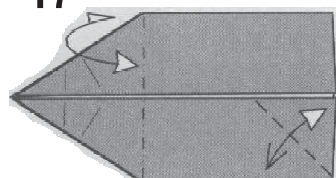

18

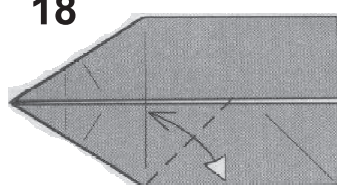

19

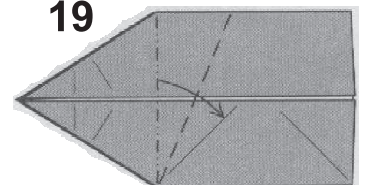

20

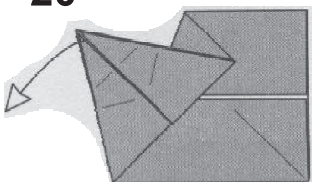

21

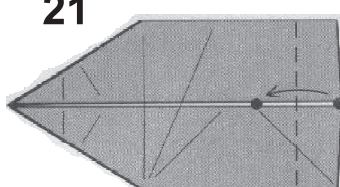

22

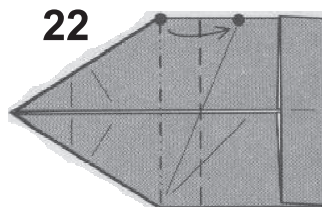

23

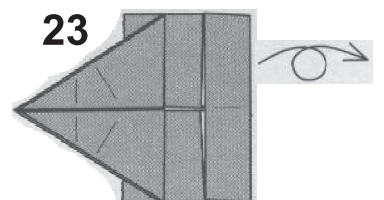

24

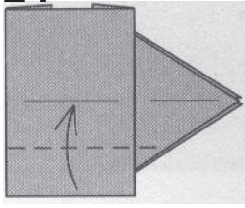

25

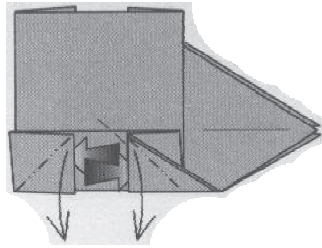

26

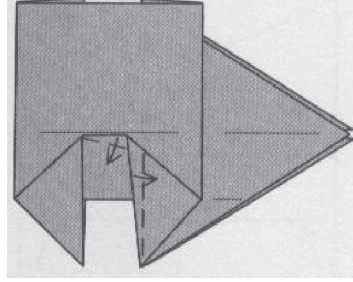

27

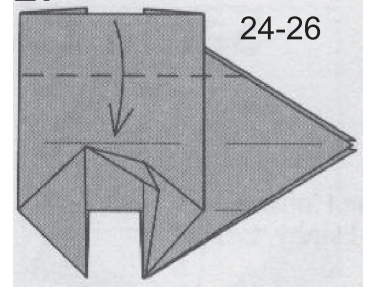

28

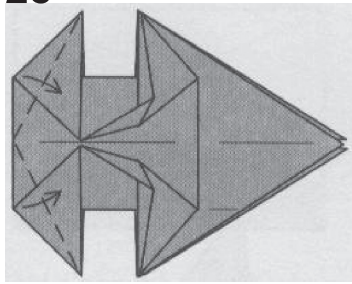

29

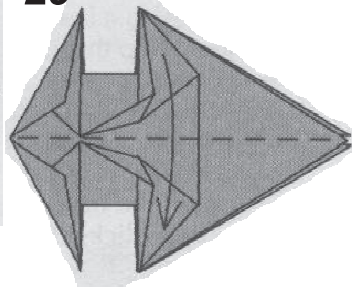

30

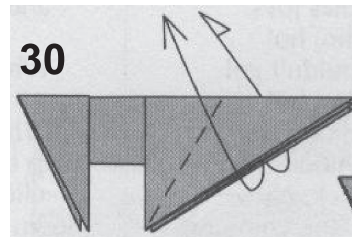

31

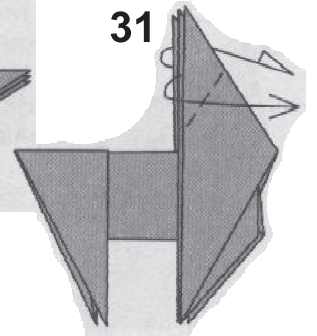

32

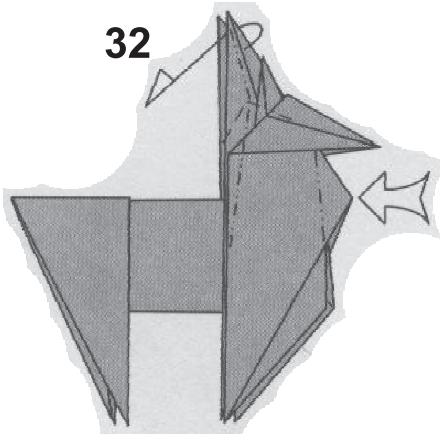

33

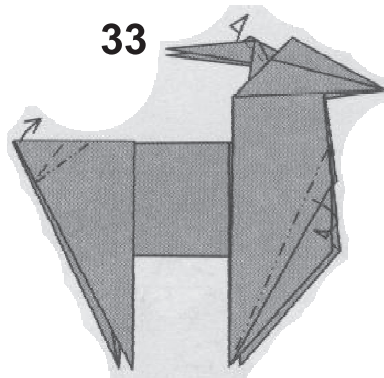

34

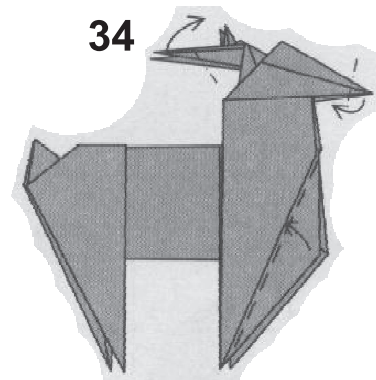

35

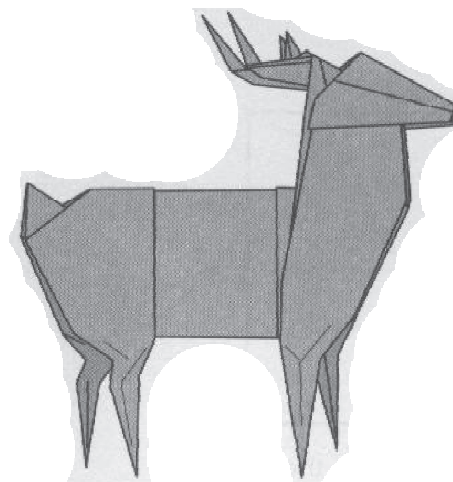
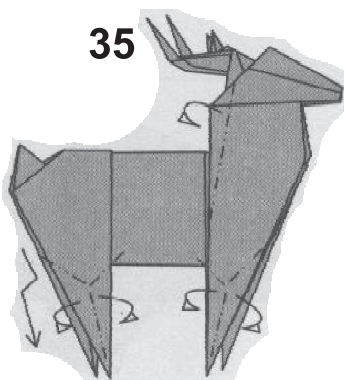



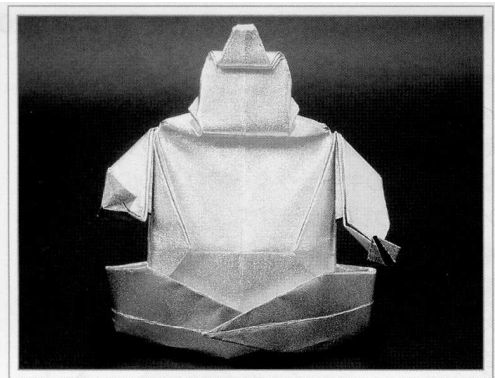

# Большой Будда

Кунихико Касахара, Япония

Monthly ORIGAMI Magazine No. 423 - 2010.11

Базовая форма "Лягушка"

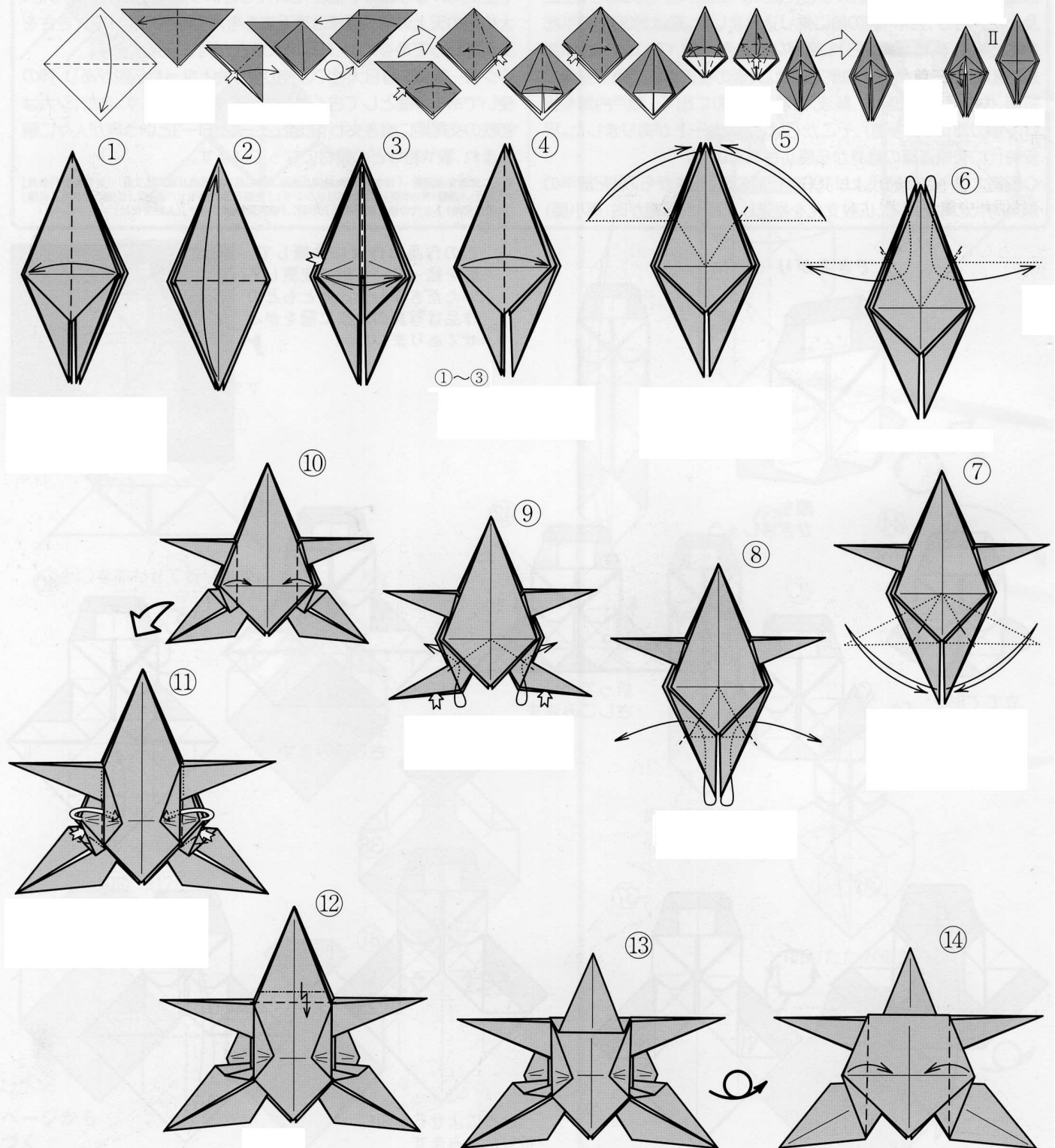

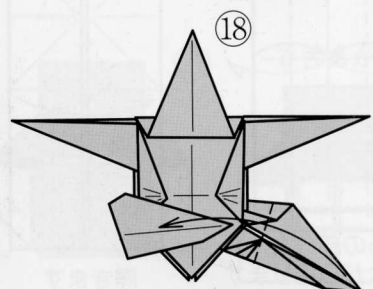
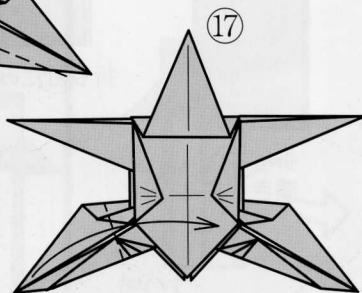
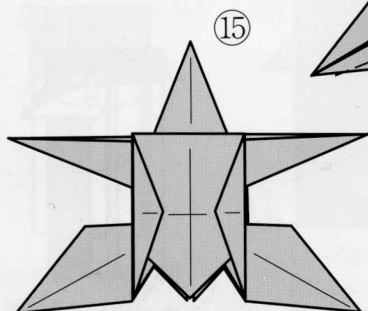
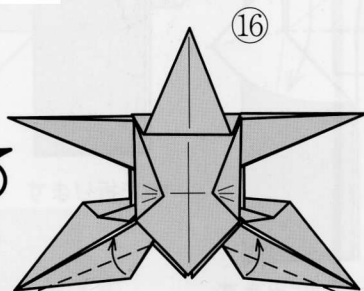
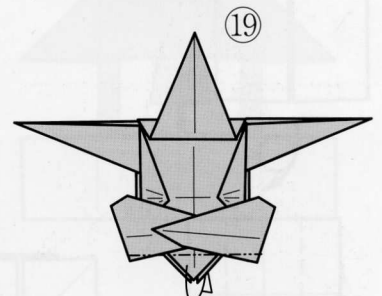
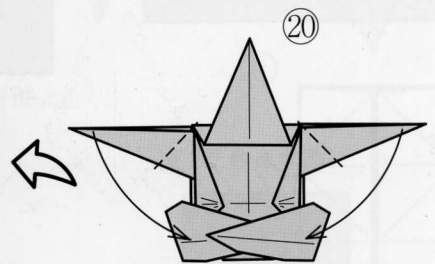
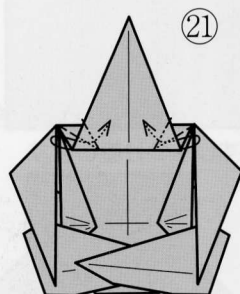
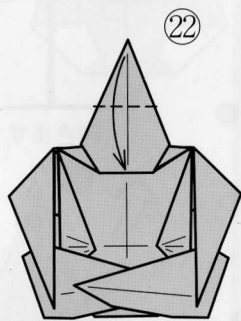
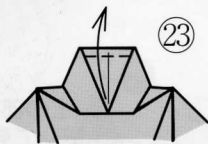
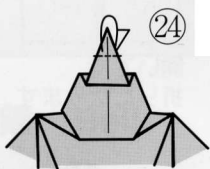
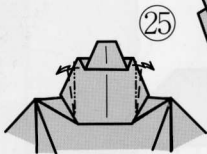
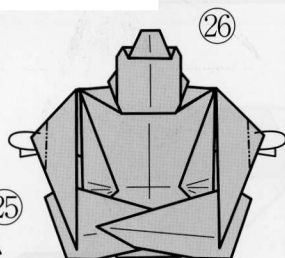
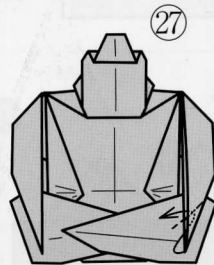
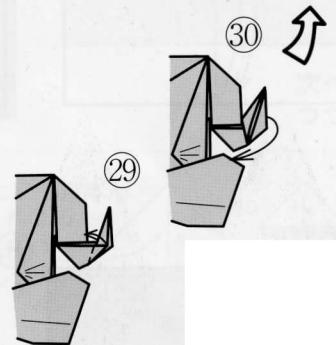
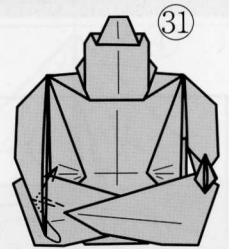
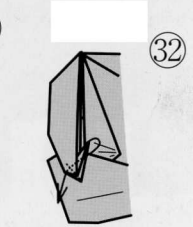
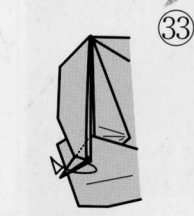
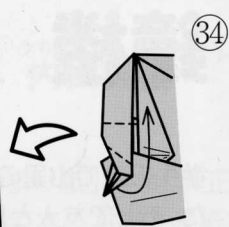
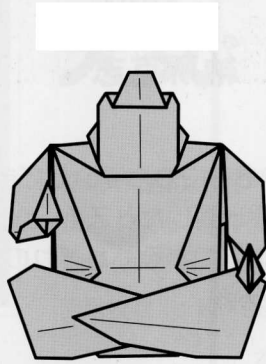
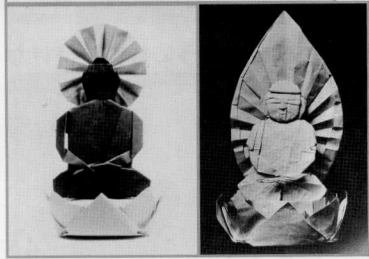



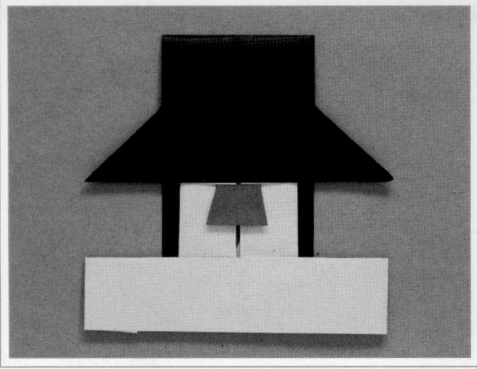

# Колокольня

Кацуси Носё, Япония

Monthly ORIGAMI Magazine No. 423 - 2010.11

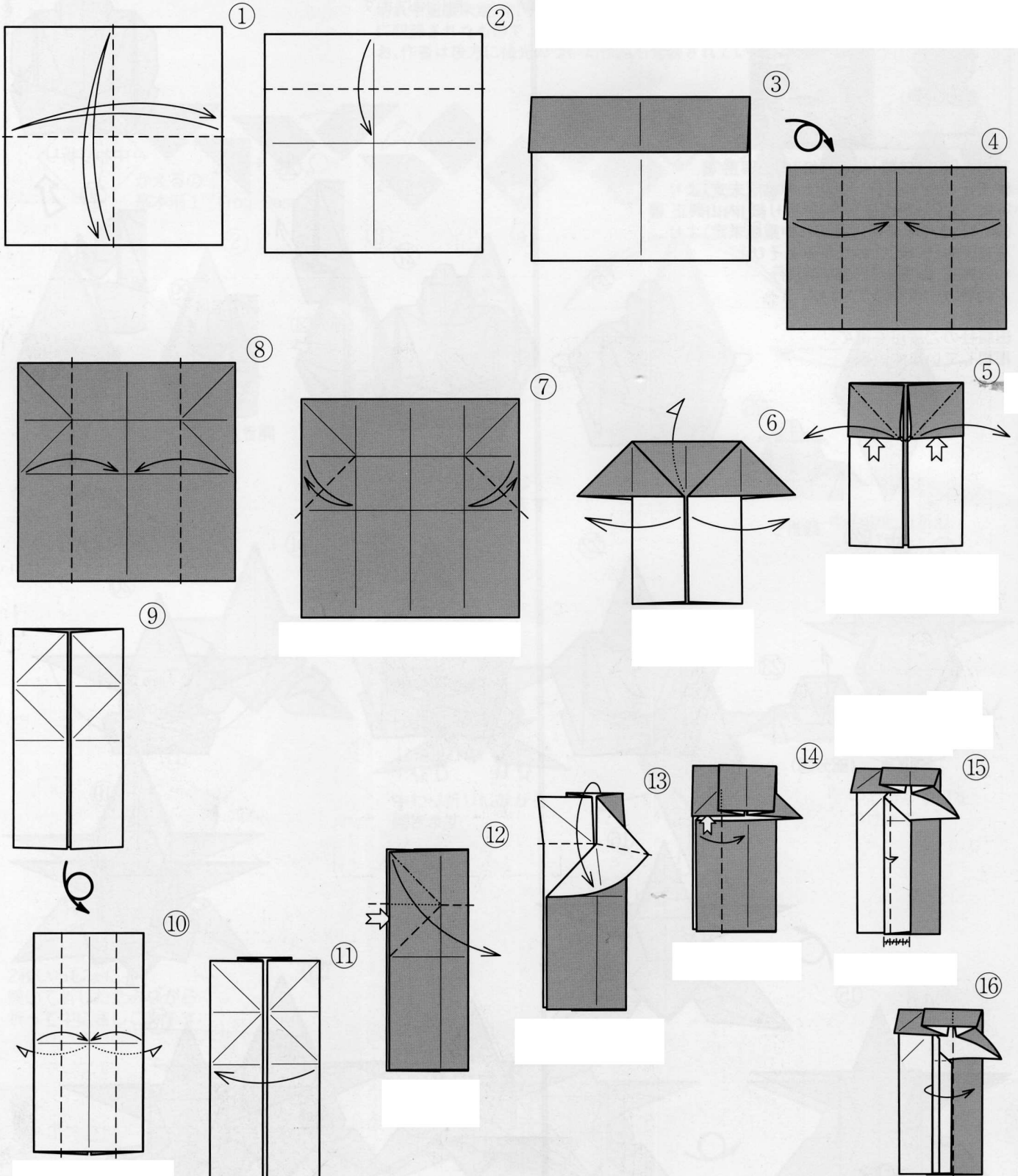

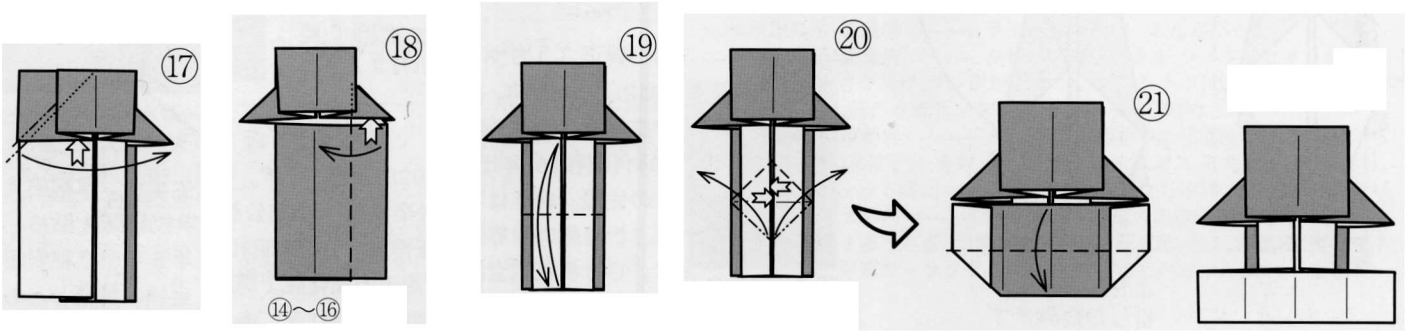

Соотношение деталей

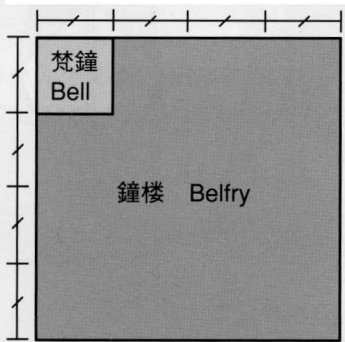

Базовая форма "Воздушный змей"

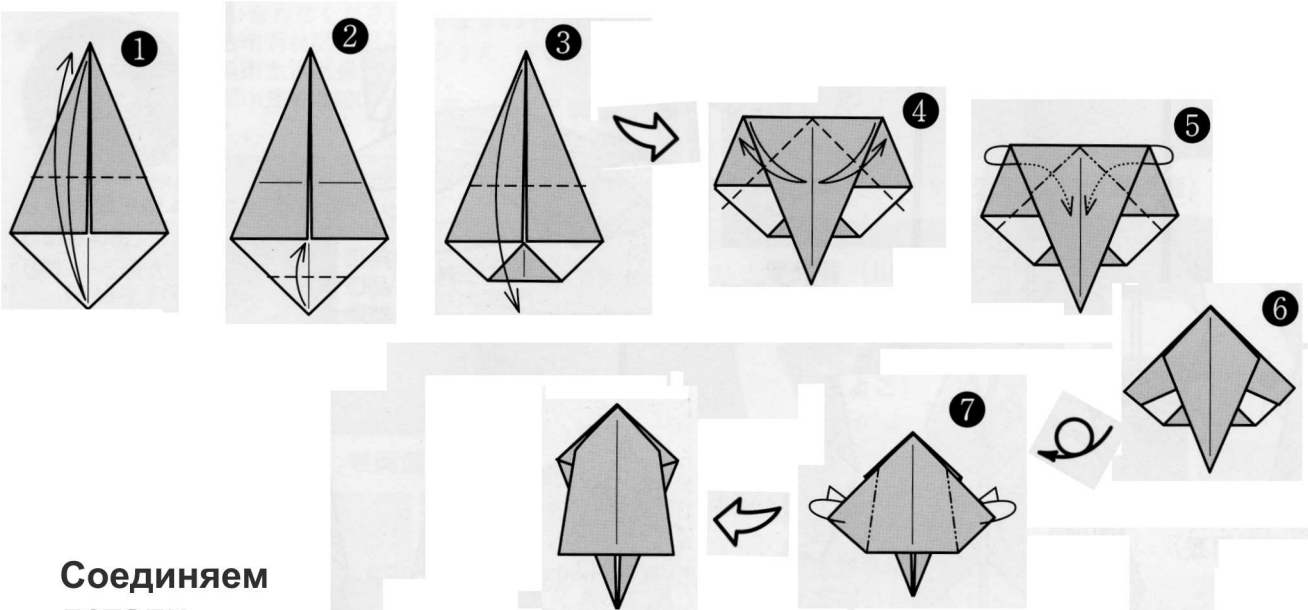
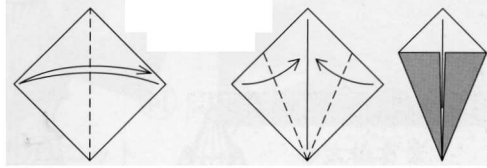

Соединяем детали

