

Тушечница и перо

Сёко Аояги, Япония

Monthly ORIGAMI Magazine № 440, 2012.4

Флакон

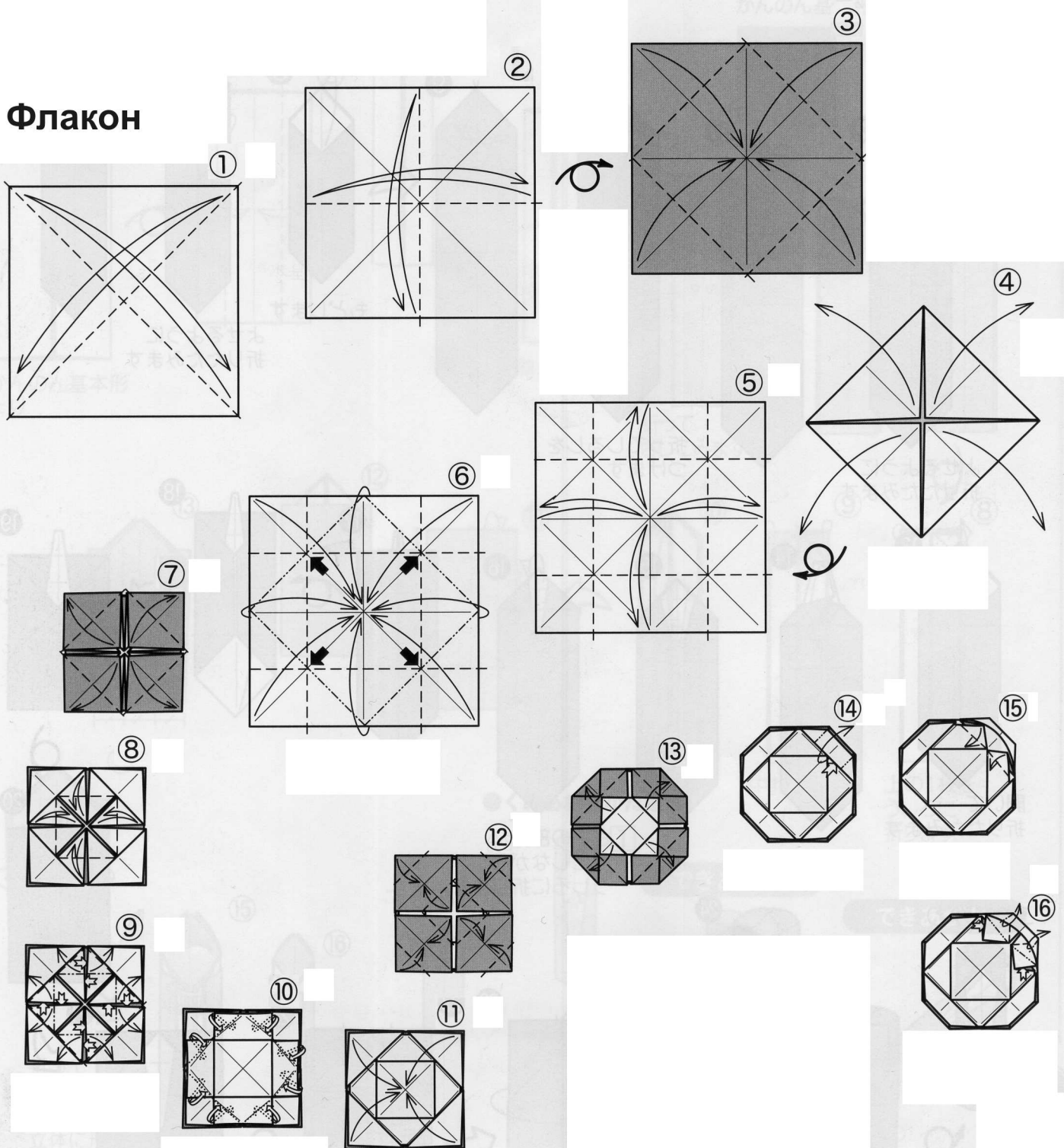

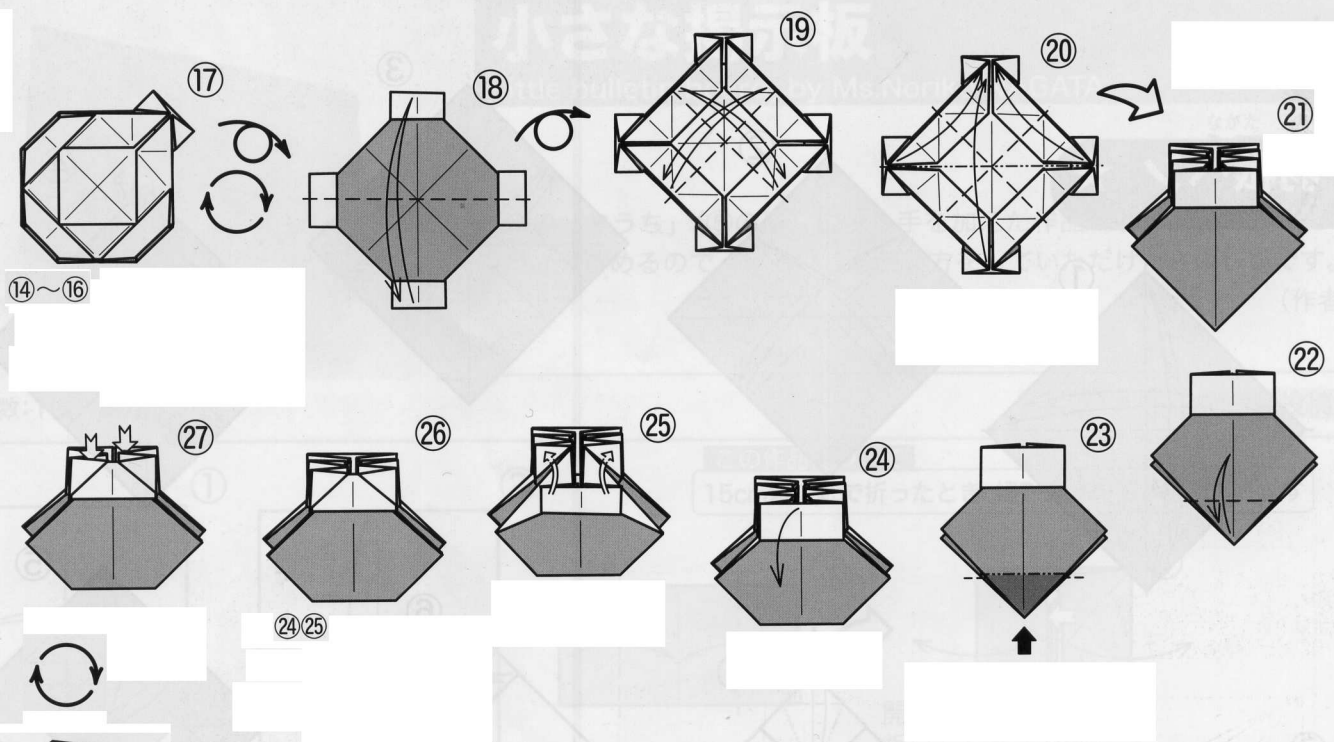

Соединяем детали

Базовая форма "Блинчик"

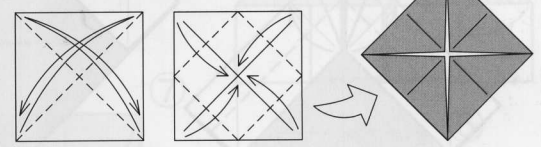
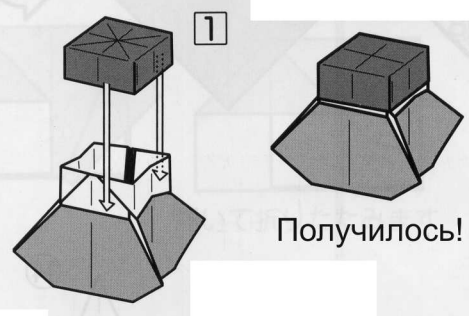

Готово!

Получилось!

Крышка

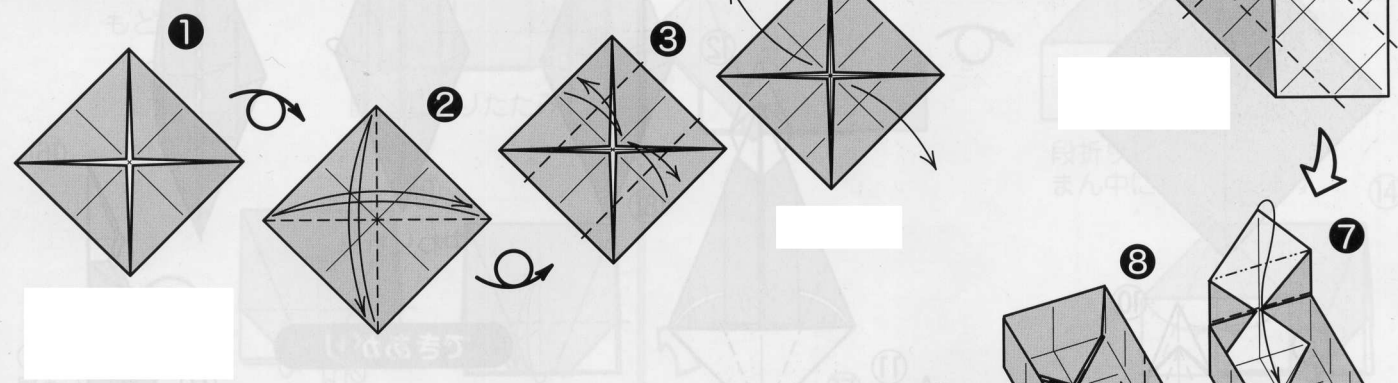

Соотношение деталей

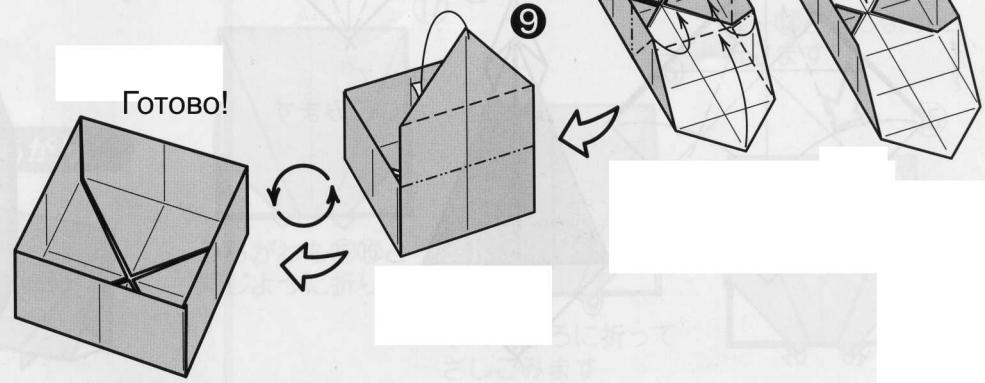

Перо

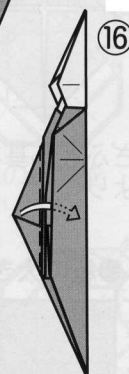
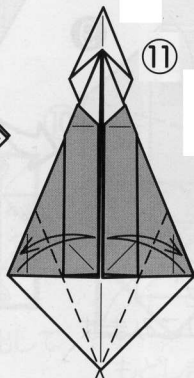
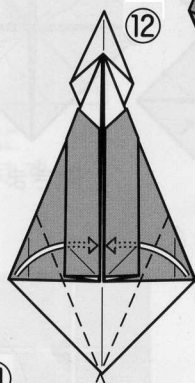
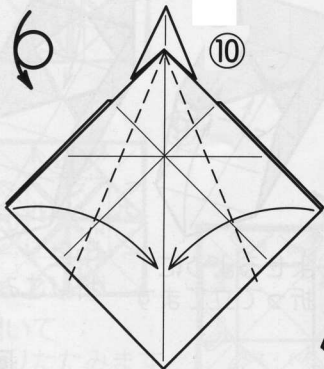
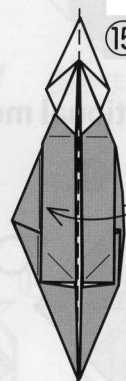
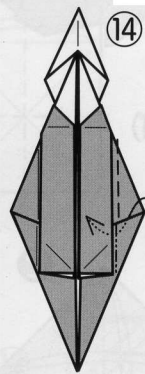
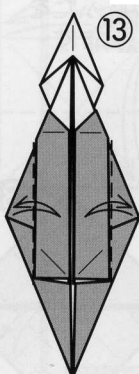
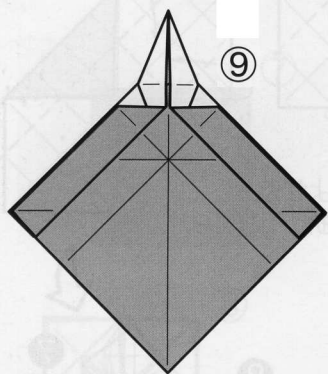
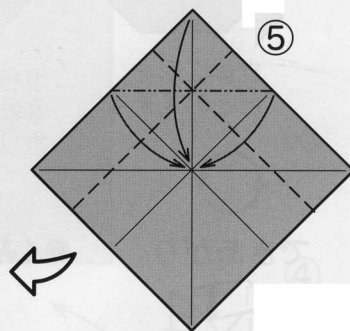
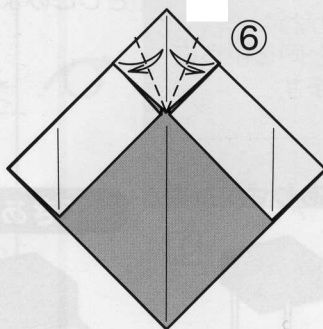
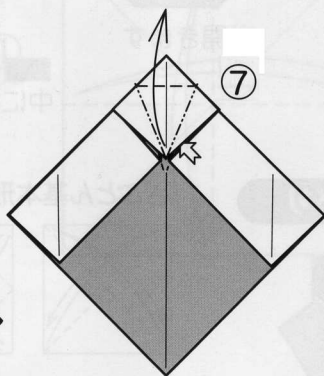
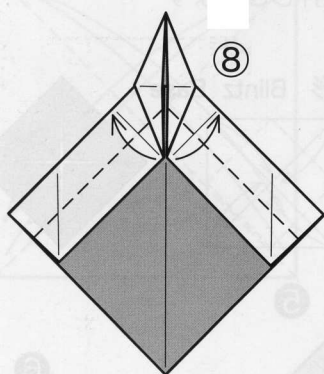
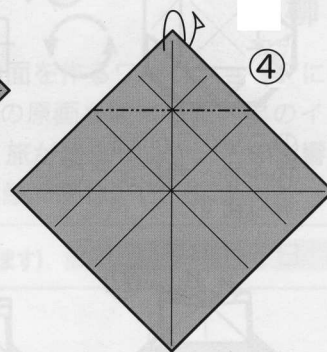
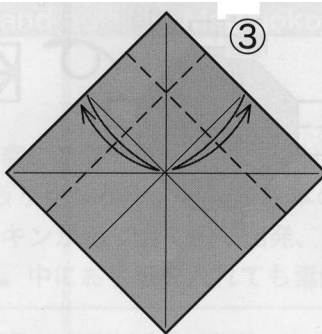
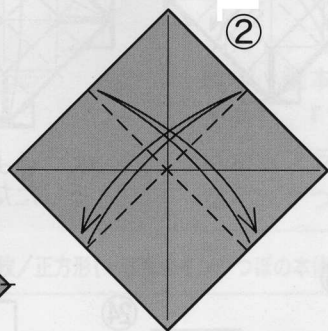
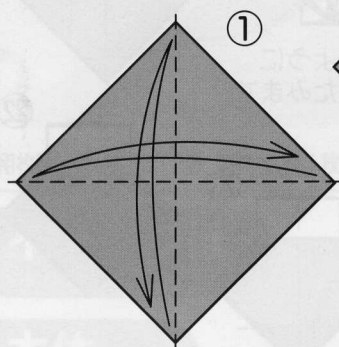

Получилось!

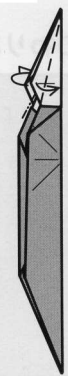
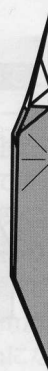

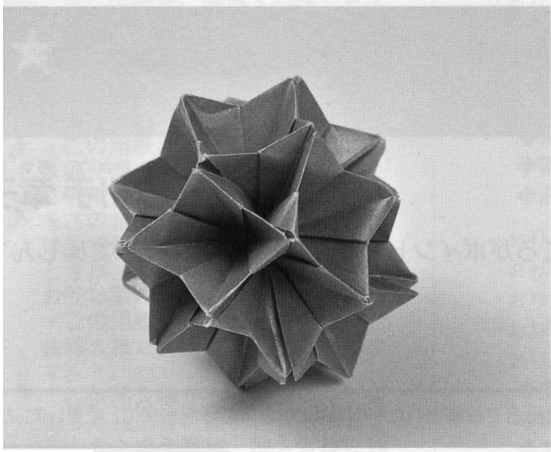

Шар из колокольчиков

Хадзимэ Комия, Япония

Monthly ORIGAMI Magazine № 433, 2011.9

Потребуется 18 листов

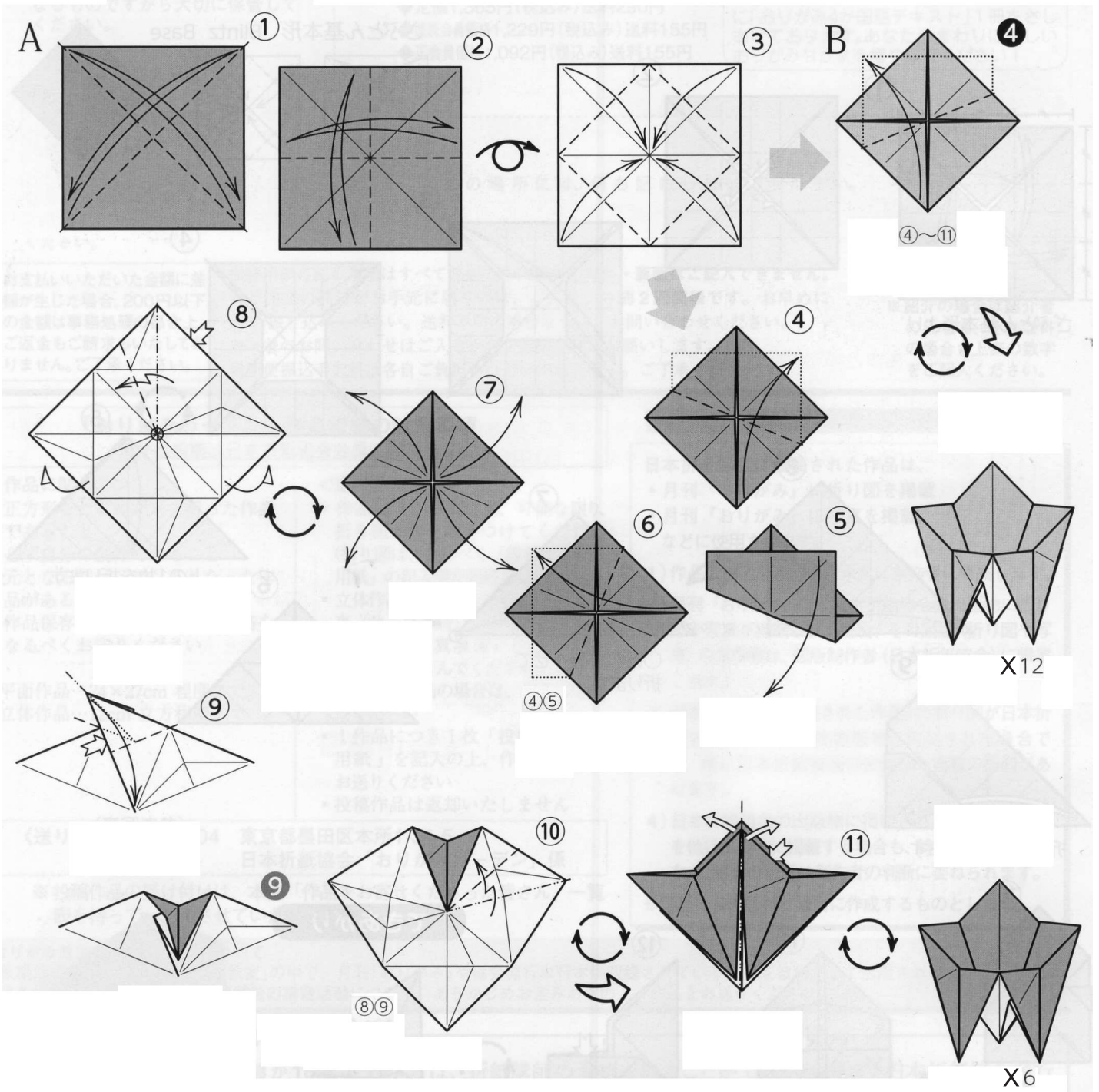

Соединяем детали

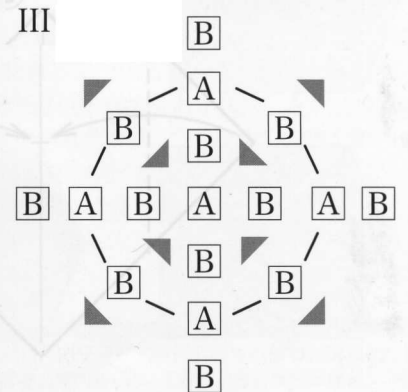
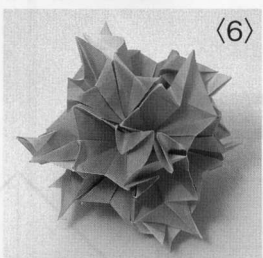
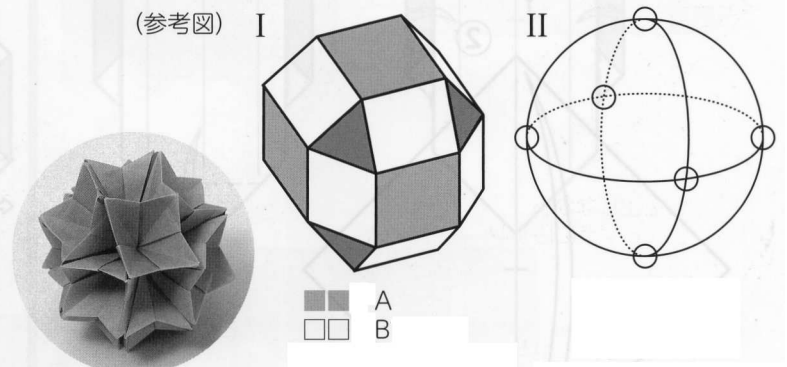
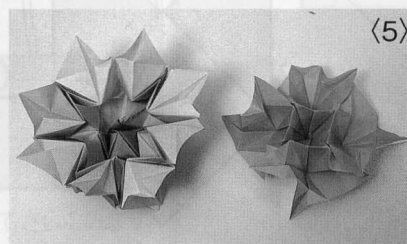
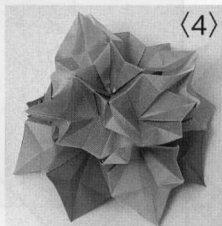
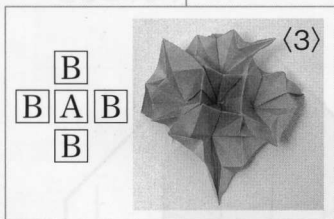
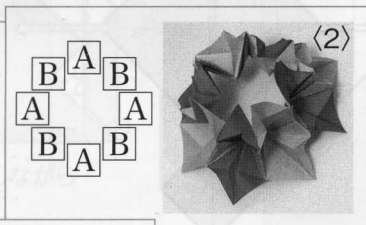
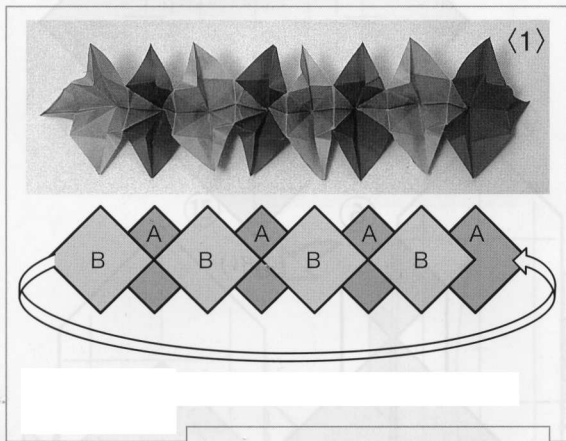
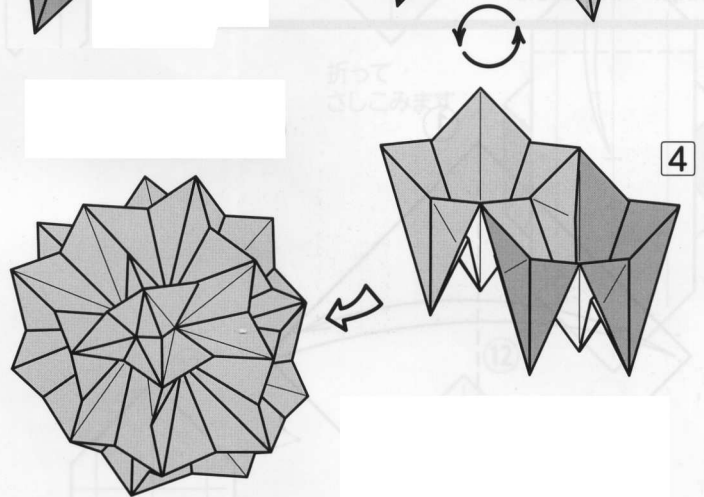
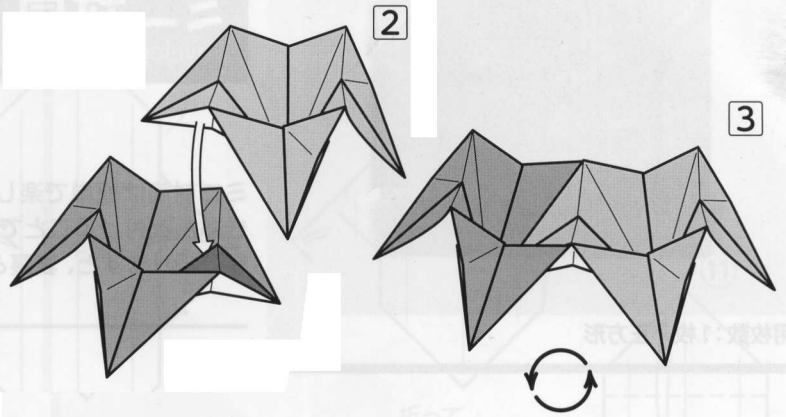
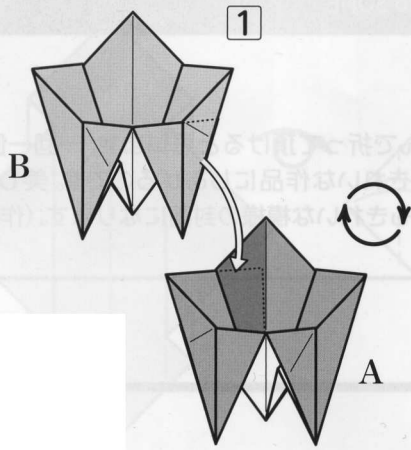

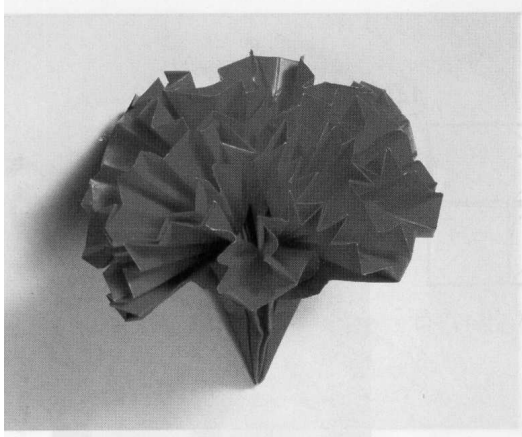

Цветок звезды

Манабу Итикава, Япония

Monthly ORIGAMI Magazine № 429, 2011.5

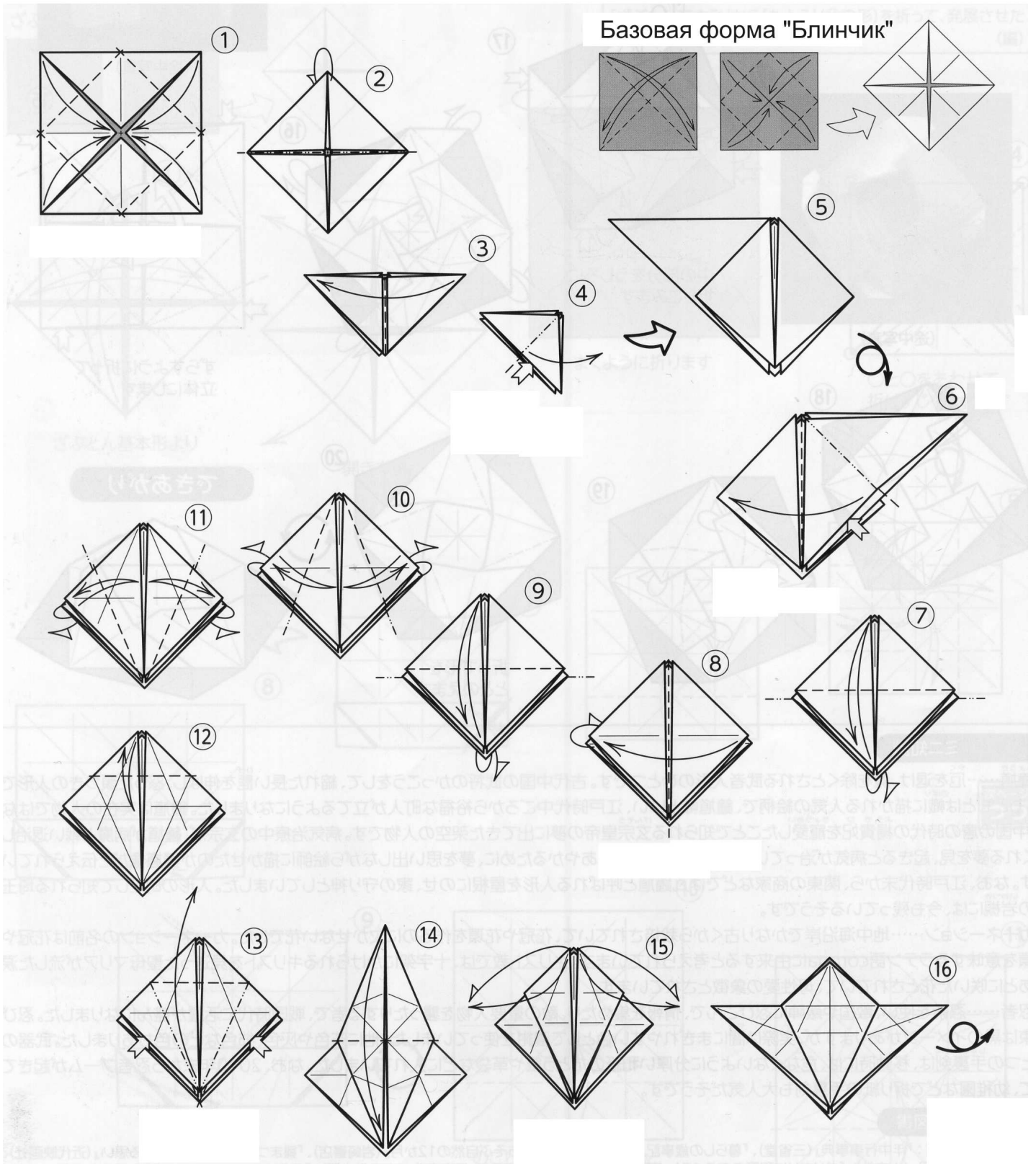

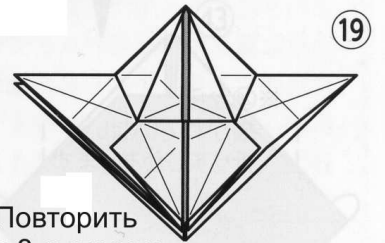
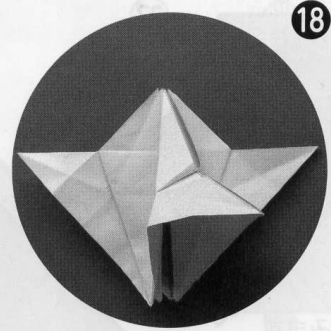
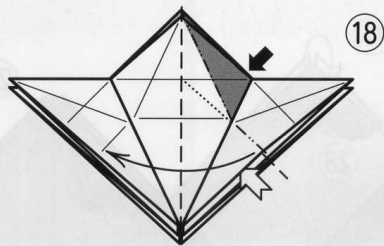
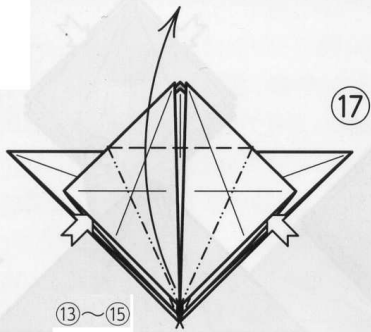

Повторить с 3-х сторон

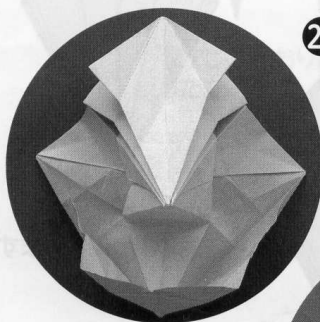
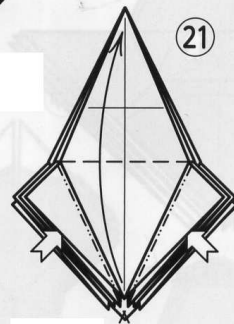
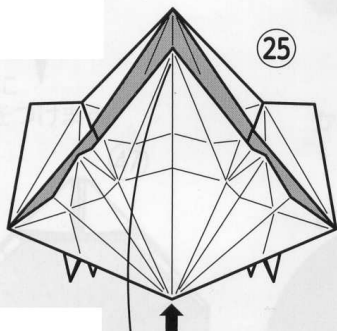
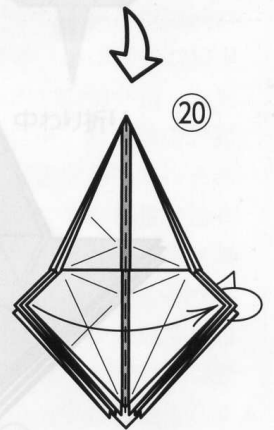
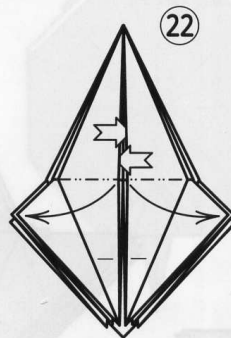
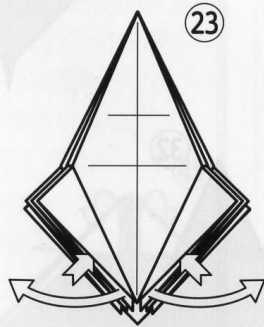
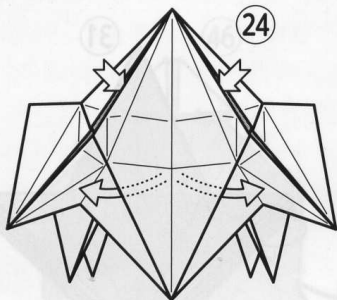

25-1

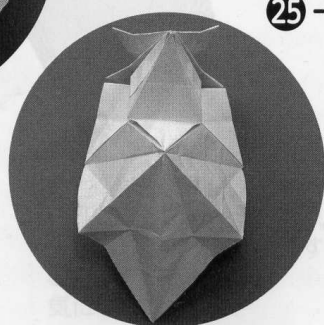

25-2

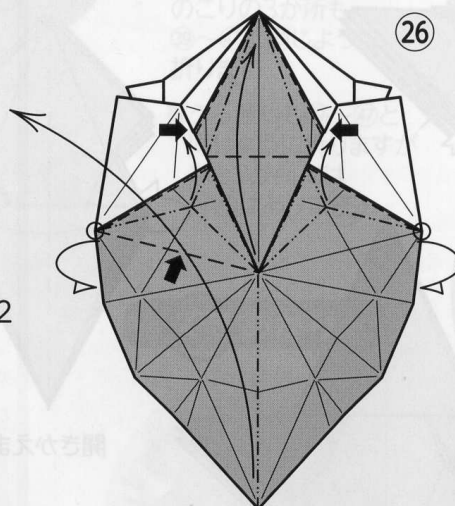

26

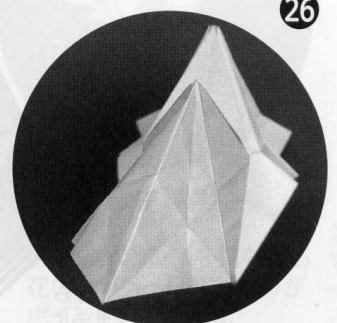

26

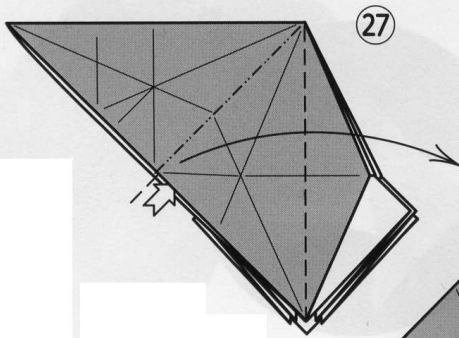

27

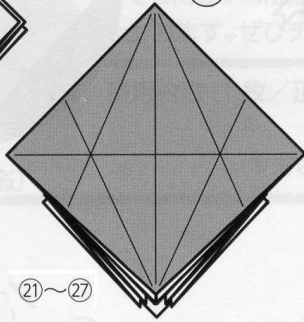

28

21~27

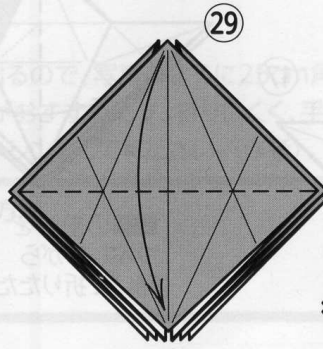

29

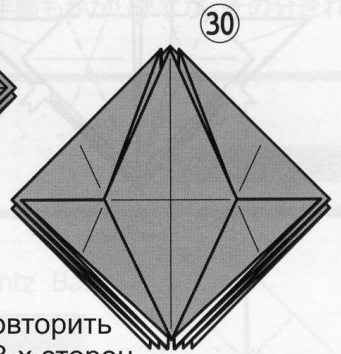

30

Повторить с 3-х сторон

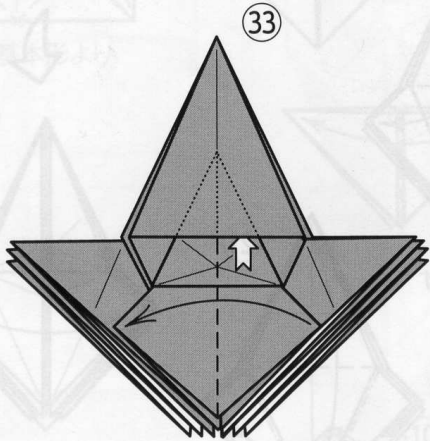

33

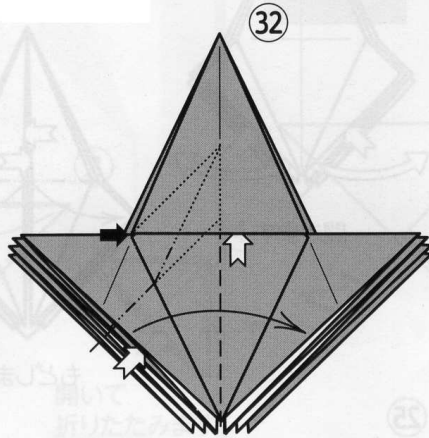

32

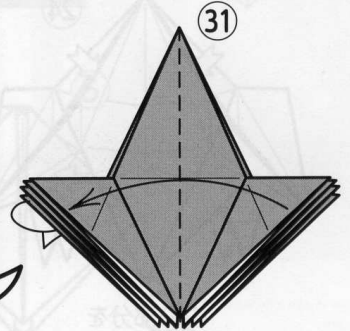

31

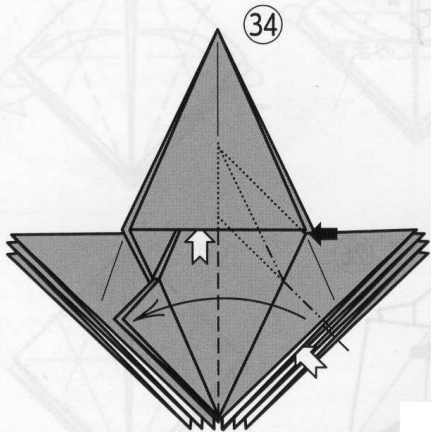

34

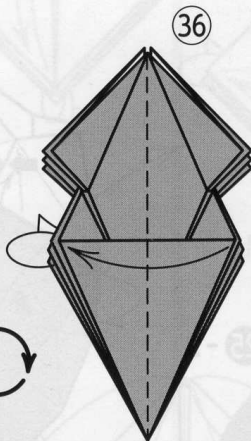

36

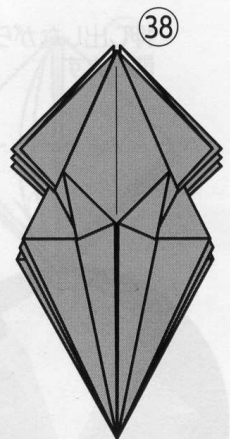

38

Повторить с 3-х сторон

32 33

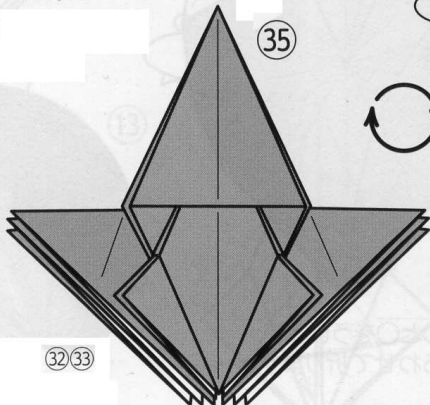

35

32 33

37

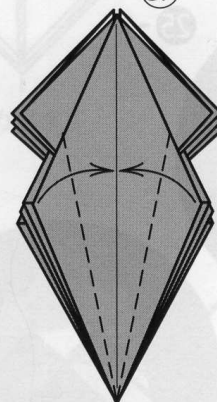

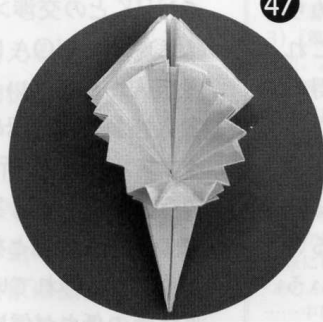
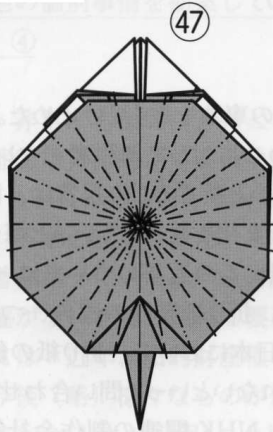
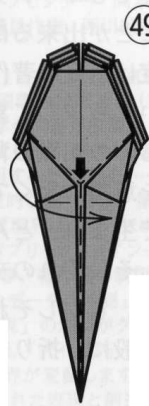
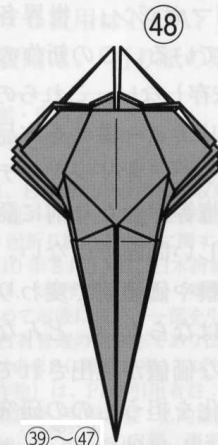
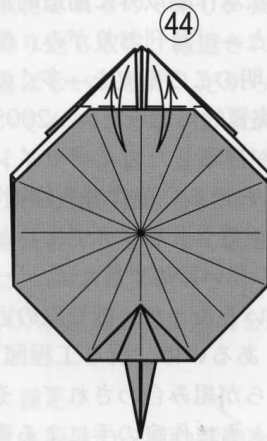
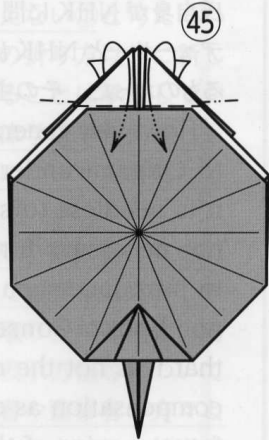
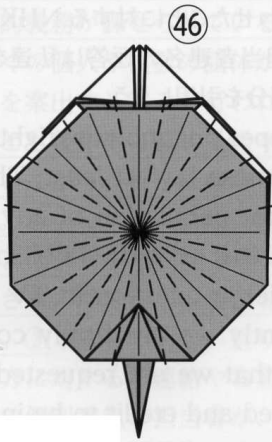
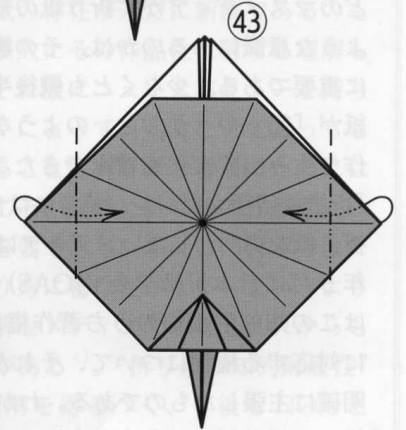
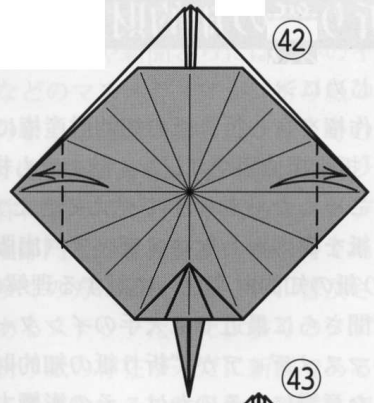
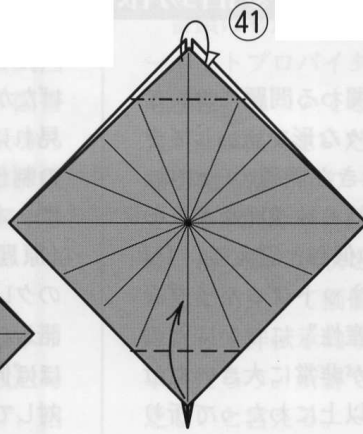
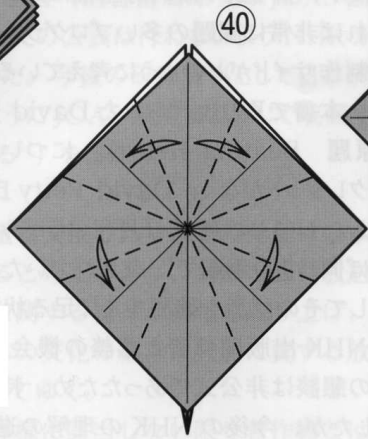
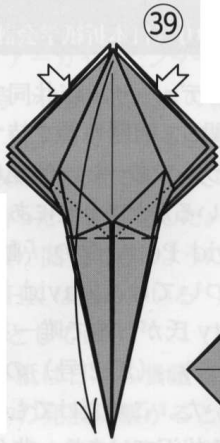

39~47

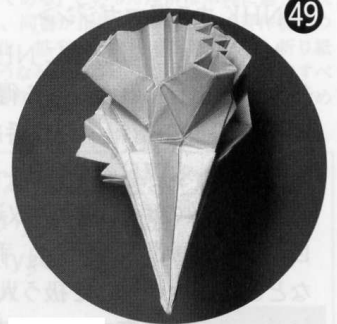
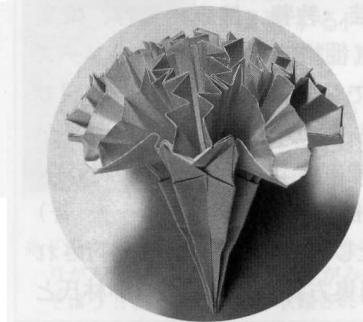
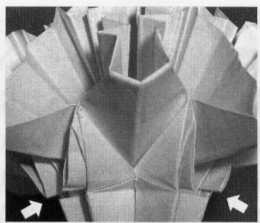

49